

Article number: 20241043610

Description: E+G Telescope-Lear motion bearings GN 2410-43-610

Measures

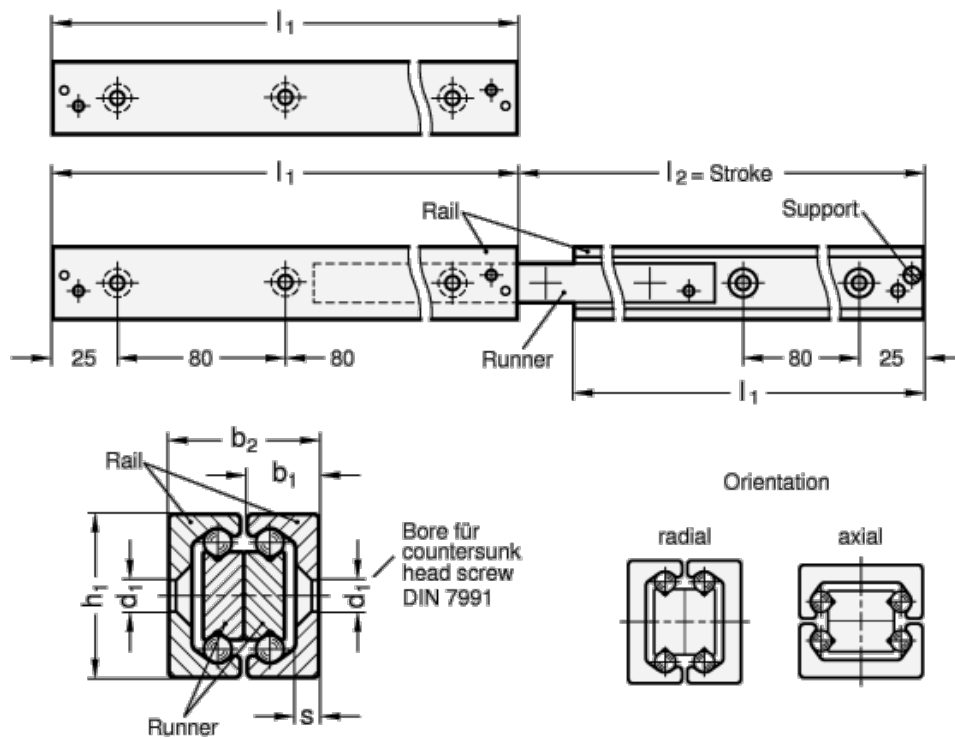

b1	= 21
b2	= 44
d1	= M8
d2	= 8.5
h1	= 43
L1	= 610 - 626
s	= 4.5
Weight in (g)	= 6770